

CONTROL PANEL 0518-2-1517

MOUNTING

The control panel is splash proof and may be mounted in the damp area adjacent to the cabin. The thermostat sensor must be wall mounted within the sauna. Please follow the measurements in the heater instructions to avoid the possibility of scorching the wood.

TIMER

The timer (2) is the main on/off switch for the controlpanel. To switch on, turn knob clockwise: The scale provides first a 1-4hr working band, then a 1-8hr preset band, which delays the switch on time. The pilot light (3) shows when the heater is on.

When the sauna is finished, the timer knob may be turned back to the off position or left to switch off automatically at the end of the set working time.

REGULATION OF TEMPERATURE

The thermostat control (1) regulates temperature. Turn clockwise to achieve stepless increase of temperature level in the sauna. Resetting the thermostat each time the sauna is used is unnecessary. When the position which maintains the desired temperature has been found, the knob may be permanently left at this setting.

LIGHT SWITCH

A rocker-switch (5) is provided for connections to the light fitting in the sauna

SENSOR UNIT

The recommended mounting dimensions for the sensor are shown in the heater instructions. A 3 metre length of heat-resistant cable (170°C) 4 x 0,25mm² - is provided. This may be extended with normal low voltage cable Outside the sauna cabin. Connection details for the sensor are shown in fig. 4.

LIMIT CONTROL

If the temperature in the sauna should rise too high (for example due to a thermostat fault) the limit switch in the sensor will turn off the power. When the fault has been rectified the switch may be reset.

Fig 3

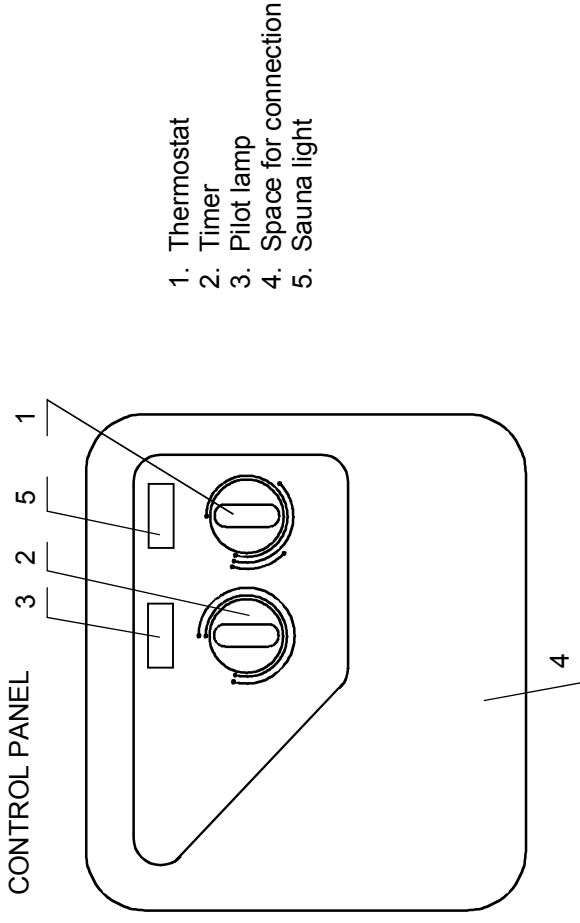

1. Thermostat
2. Timer
3. Pilot lamp
4. Space for connection
5. Sauna light

Fig 4

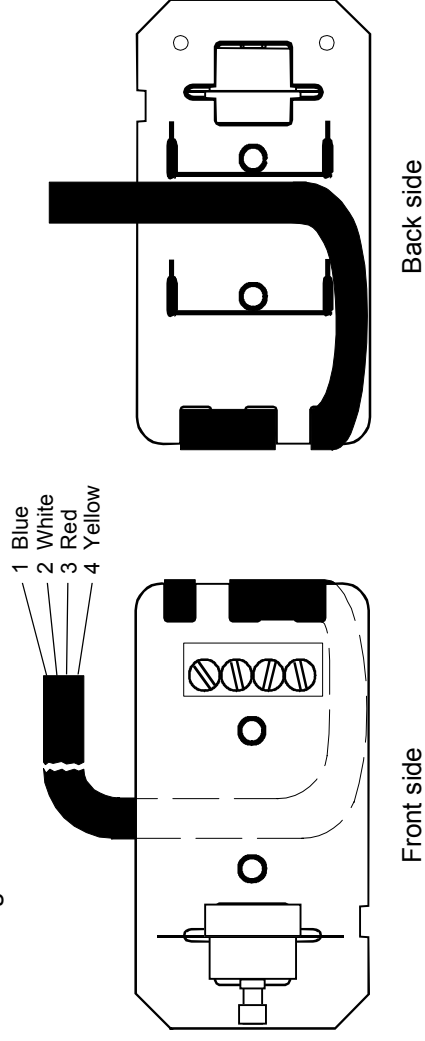

- Sensor installation

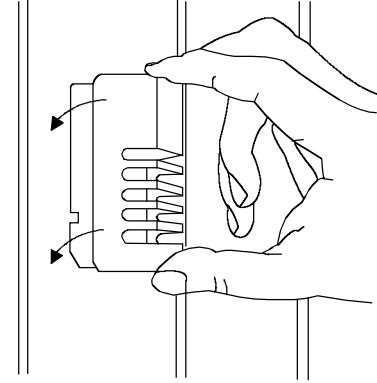
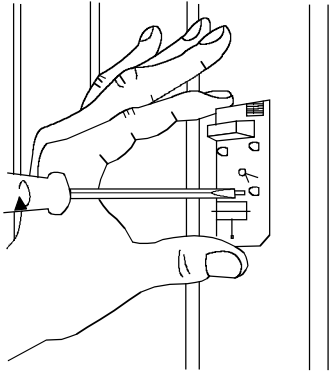
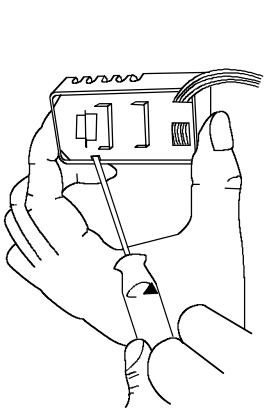

- Removal of the cover

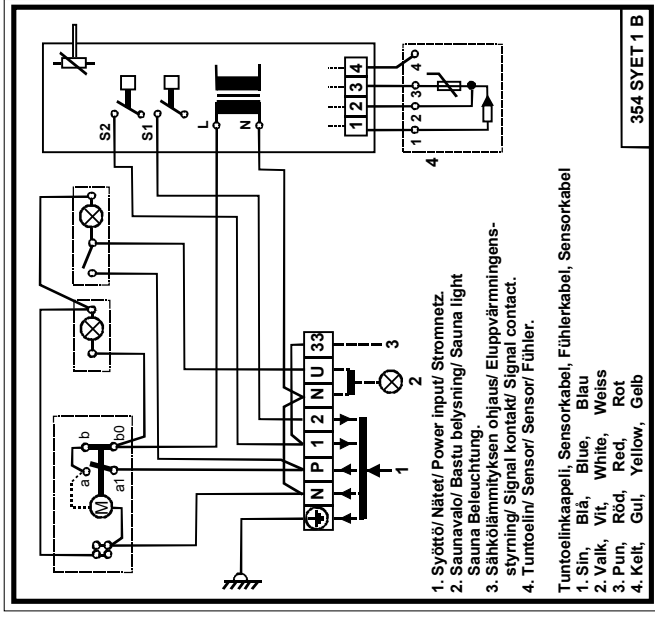
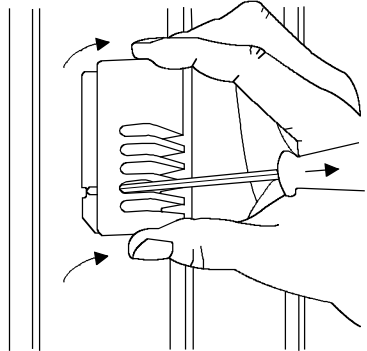
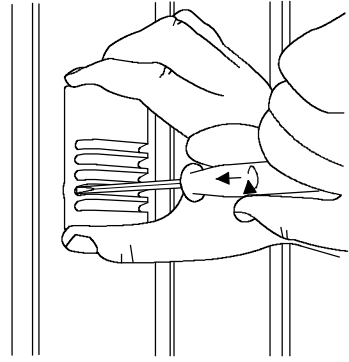

The sensor must be installed as shown in the illustration below.
 Digression from these instructions may cause overheating and risk for fire

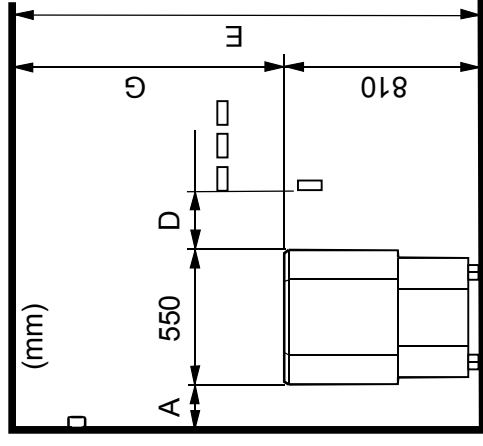
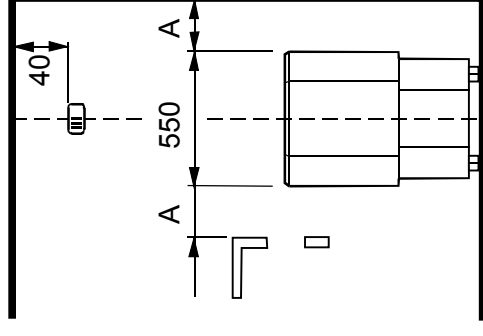

Heater	Distance (mm)			
	A	D	E	G
1120-9-1705	60	40	1900	1090
1120-12-1705	80	50	2100	1290
1120-15-1705	100	60	2100	1290