

# wave.com4 Infra

## INFRARED CONTROL

### OPERATING INSTRUCTIONS



The unique high-end infrared control with modular design, which can be operated from the outside as well as from the inside.

## TABLE OF CONTENTS

### 1. INSTALLATION INSTRUCTIONS FOR QUALIFIED PERSONNEL ONLY 4

<b>GENERAL SAFETY INFORMATION .....</b>	<b>5</b>
1.1. SCOPE OF DELIVERY AND ACCESSORIES.....	5
1.2. INSTALLING THE POWER UNIT .....	6
1.3. INSTALLING THE OPERATING UNIT .....	9
1.4. INSTALLING THE TEMPERATURE SENSOR.....	10
1.5. INSTALLING THE FOIL TEMPERATURE SENSOR.....	11
1.6. MASTER/SLAVE CONFIGURATION .....	12
1.6.1 Master/Slave configuration of <b>two</b> wave.com4 Infra power units	
1.6.2 Master/slave configuration of <b>three to five</b> wave.com4 Infra power units	
1.7. HEATING ROD SYSTEM CONFIGURATION / FOIL SYSTEM .....	14
1.8. ACTIVATION OF THE OPT. FOIL SENSOR FOR SLAVE POWER UNITS.....	14

### 2. USER INSTRUCTIONS FOR THE USER..... 15

<b>GENERAL SAFETY INFORMATION .....</b>	<b>16</b>
2.1 OPERATING MODES.....	16
2.1.1 What operating modes are there? .....	16
2.1.2 What can I set?.....	17
2.1.3 What setting ranges do I have? .....	17
2.2 CLEANING.....	17
2.3 ERROR MESSAGES .....	18
2.4 OPERATION .....	19
2.4.1 Display elements .....	19
2.4.2 Operating elements .....	19
2.5 OPERATING MODES .....	20
2.5.1 Changing the operating mode .....	20
2.5.2 Intensity control mode .....	21
2.5.3 Room temperature control mode .....	22
2.5.4 Program mode .....	23
2.6 EXTENDED FUNCTIONS AND SETTING OPTIONS.....	25
2.6.1 Remote start.....	25
2.6.2 Resetting the max. heating period.....	26
2.6.3 Controlling the potential-free switching outputs .....	26

### 3. TECHNICAL DATA..... 27

3.1. OPERATING UNIT.....	27
3.2. POWER UNIT .....	27

WE DO IT FIRST.

## 1. INSTALLATION INSTRUCTIONS FOR QUALIFIED PERSONNEL ONLY

**Dear Installer,**

- Please read these instructions carefully before using the infrared control. This way, you can utilize all the advantages the device has to offer and prevent damage.
- 
- Installation should only be carried out by a qualified electrician or a similarly qualified person.
- When special problems occur which are not treated in detail in these instructions, contact your supplier for your own safety.
- Children should be supervised to make sure that they do not play with the device.
- This device is not meant to be used by persons (including children) with limited physical, sensory or mental capabilities or who lack experience and/or knowledge, unless they are supervised by a person responsible for their safety or have received instruction on how the device is to be used.
- Unauthorized changes or conversions to the infrared control are not allowed for safety reasons.
- Keep these instructions near the infrared control, in order to be able to look up safety information and important information for operation at any time.
- Subject to technical changes.

**WE DO IT FIRST.**

## General safety information

### Intended use:

- Among other things, the infrared control is for controlling and regulating the interior temperature
  - for infrared foil heating systems, in the range from 30-50°C,
  - for infrared rod heating systems, in the range from 30-70°C.
- The infrared control may only be used for controlling and regulating 2 heating circuits with a maximum of 1.5 kW heating power per heating circuit.
- The power unit may only be installed and operated in connection with the operating unit included in the scope of delivery.
- Only the mains connection line in the associated plug set (article no.: WC4-P-Set) may be used.

## 1.1 Scope of delivery and accessories

### Scope of delivery

- wave.com4 Infra power unit
- wave.com4 temperature sensor
- Silicone connection line, 5 m
- 1x fastening screw 3x25
- 4x fastening screws 4x16 mm
- Operating instructions

### Accessories

- |   |                     |
|---|---------------------|
| ▪ wave.com4 operating unit, dark wood             | Art. no.: WC4-IRX-D |
| ▪ wave.com4 operating unit, light wood            | Art. no.: WC4-IRX-H |
| ▪ wave.com4 operating unit, black                 | Art. no.: WC4-IRX-B |
| ▪ wave.com4 operating unit, white                 | Art. no.: WC4-IRX-W |
| ▪ Plug set wave.com4 Infra incl. mains connection | Art. no.: WC4-P-Set |
| ▪ Foil sensor wave.com4 Infra                     | Art. no.: WC4-IRF-F |

WE DO IT FIRST.

## 1.2 Installing the power unit

The power unit is mounted on the cabin ceiling (see Fig. [1](#)), on the cabin wall or according to manufacturer recommendations. The power supply has a mains connection line with shock-proof plug (not included in the scope of delivery, only available as accessory).

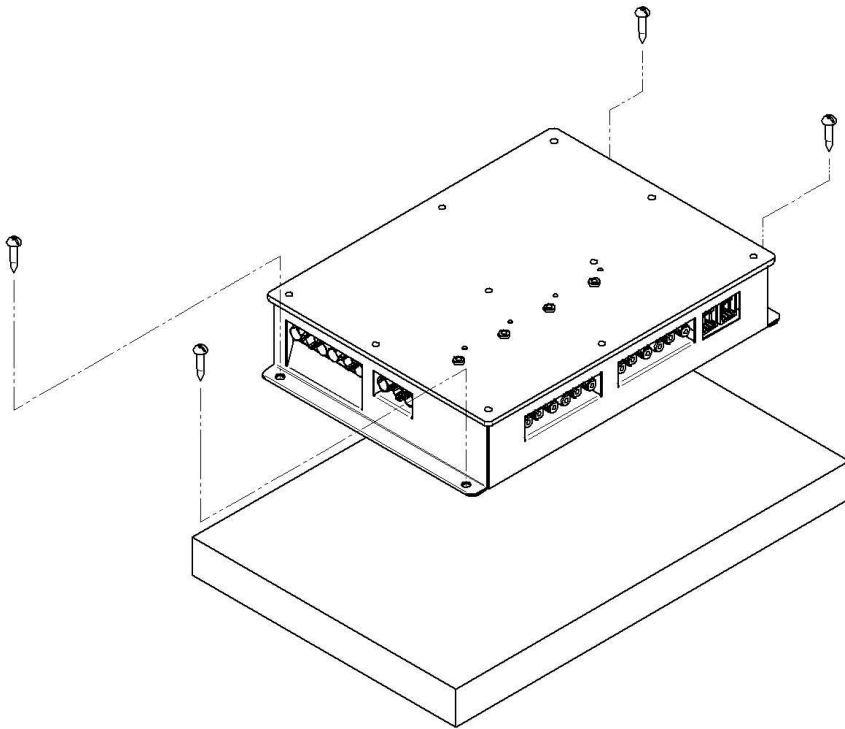

Fig. [1](#)

**CAUTION - Damage to device:** Mount the power supply in a dry place. Maintain the ambient conditions of max. 40°C and a maximum humidity of 95%.

1. Screw the wave.com4 Infra housing to the cabin ceiling or wall with the four enclosed wood screws (16 mm long).
2. Stick the 4-pin RJ11 data cable into the 4-pin operating unit socket on the side of the housing. (see Fig. [2](#))

**CAUTION - Damage to device:** The infrared control may only be used for controlling and regulating 2 heating circuits with a maximum of 1.5 kW of heating power per heating circuit.

WE DO IT FIRST.

3. All components are connected to the wave.com4 Infra power unit according to Figure 2

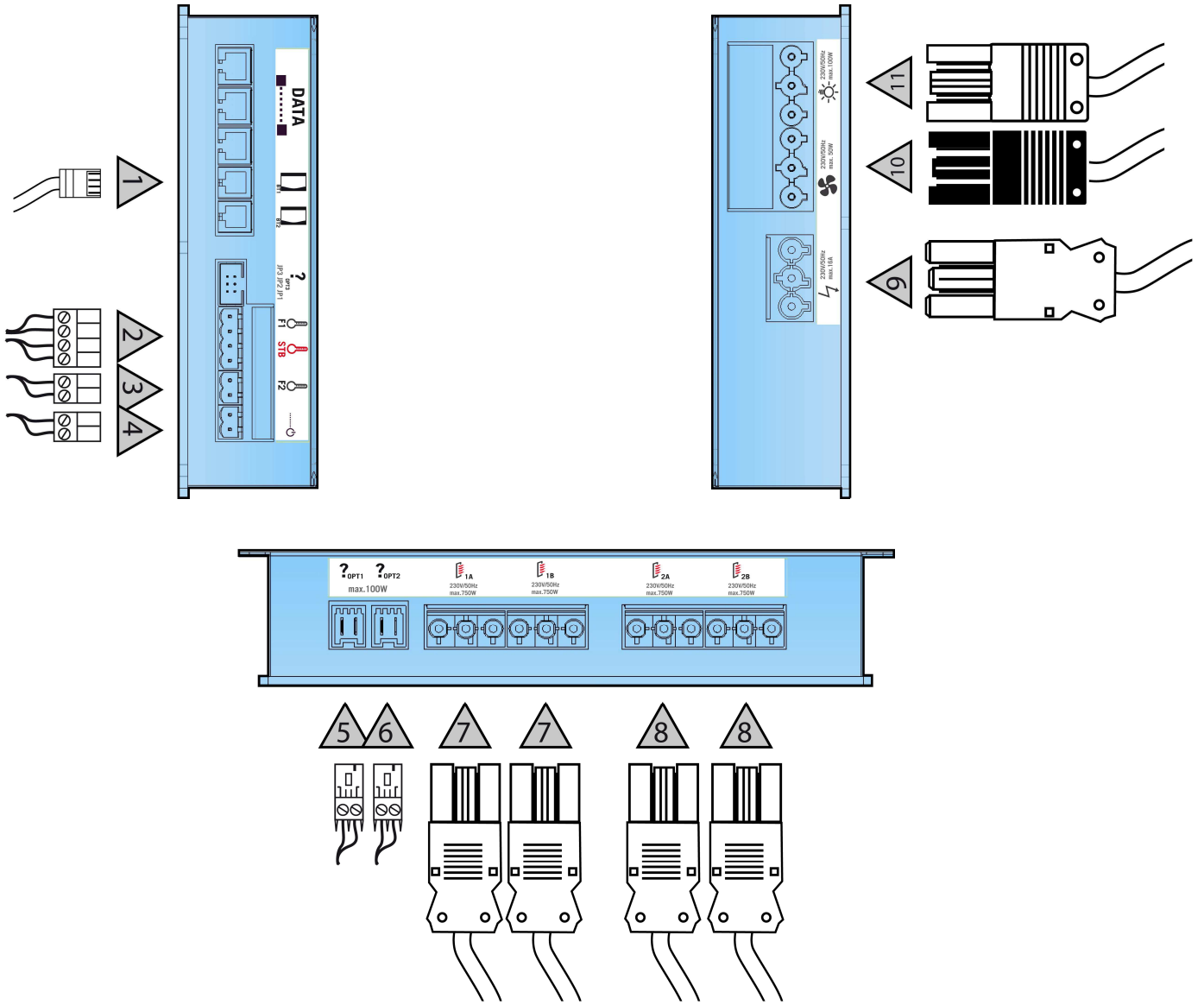













Fig. 2

WE DO IT FIRST.

The individual connections are described in the following overview:

Plug	Description	Technical data
	wave.com4 Infra operating unit	+5 VDC
	Temperature sensor & STL	Thermocouple (KTY) & Safety Temperature Limiter
	Foil temperature sensor	Thermocouple (KTY)
	Remote start contact	+12 VDC control voltage (from power unit)
	Opt. relay switching output	Potential-free switching output Max. 1150 W ~230 V
	Opt. relay switching output	Potential-free switching output Max. 1150 W ~230 VAC
	IR heating group 1	For each connection max. 750 W ~230 VAC
	IR heating group 2	For each connection max. 750 W ~230 VAC
	Mains connection	Max. 16 A, fused ~230 V 50 Hz
	Fan connection (black)	Max. 50 W ~230 V
	Light connection (green)	Max. 60 W ~230 V

The plug for connecting the heating elements, the cabin lighting and the fan are not included in delivery. The corresponding plugs without cable are available as accessories. (Article no.: WC4-P-Set)

Heating elements: White plug  
Cabin lighting: Green plug  
Cabin fan: Black plug

WE DO IT FIRST.

**CAUTION - Damage to device:** Free air circulation must be possible for the aluminium cooling plate for cooling the power unit. The power unit must not be covered by objects or materials.

### 1.3 Installing the operating unit

The operating unit ③ of the infrared control is mounted to the outer wall of the cabin at a maximum distance of 10 m away from the power supply (see Fig. ③). For mounting, a commercially available drill ( $\varnothing$  70 mm) is required. The operating unit may be mounted both inside and outside the cabin.

**CAUTION - Damage to device:** The operating unit of the infrared control is protected from dripping water (IP 43 degree of protection). Nevertheless, the operating unit must not come into direct contact with water.

1. Drill a hole in the cabin wall with a drill ( $\varnothing$  70).
2. Provide conduits for the connection lines.
3. Screw the housing to the cabin wall through the bores with the 4 enclosed wood screws.
4. Plug in the 4-pin RJ11 plug of the data cable.

Außenansicht = Outer view  
 Basisteil = Basic unit  
 Bedienteil=Operating unit

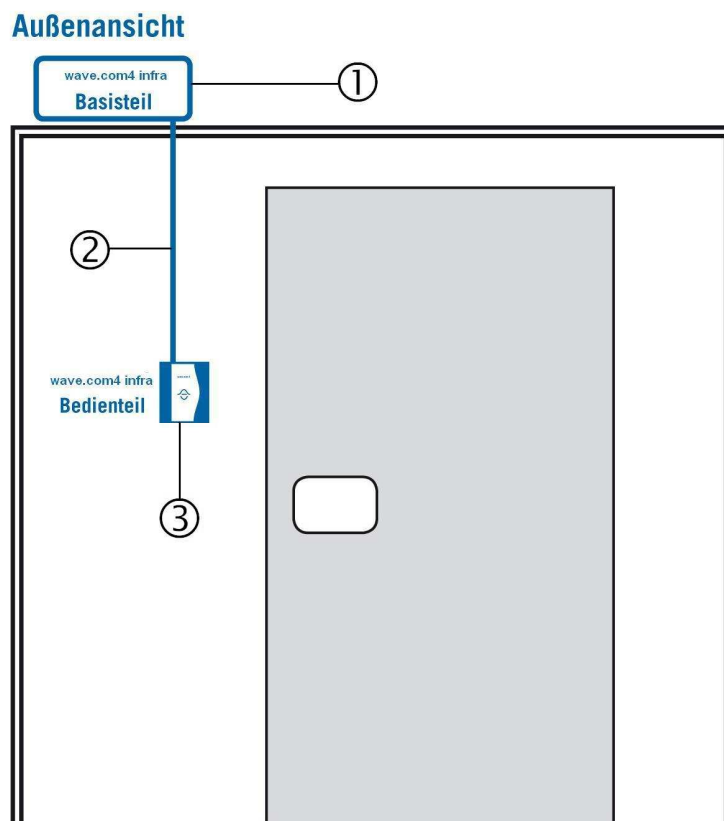

Fig. ③

WE DO IT FIRST.



## 1.4 Installing the temperature sensor

The interior temperature sensor is mounted in the infrared cabin approx. 30 cm beneath the ceiling (see Fig. 4) or according to the specifications of the cabin manufacturer.

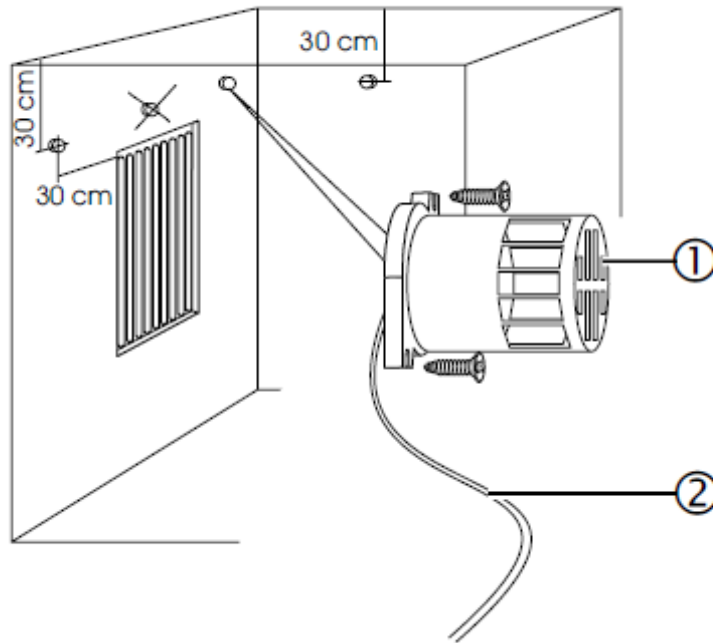

Fig. 4

**CAUTION - Incorrect measurements:** If the interior temperature sensor is mounted too close to the heater, incorrect measurements can result. Keep a minimum horizontal distance of approx. 30 cm away from the heater and approx. 30 cm to the cabin ceiling. Do not mount the interior temperature sensor above the infrared heating rods.

**CAUTION - Destruction of the heating foil:** In the case of the infrared foil heating system, the heating foil lies directly behind the sauna wall. Do not mount the interior temperature sensor directly above the heating foil.

1. Screw temperature sensor ① to the cabin wall with the two enclosed wood screws.
2. Install 2-pin cable ② in the cabin wall and fix in place with cable collars.

WE DO IT FIRST.

## 1.5 Installing the foil temperature sensor

The foil temperature sensor is mounted directly to the infrared heating foil and is fixed in place with strain relief. (see Fig. 5)

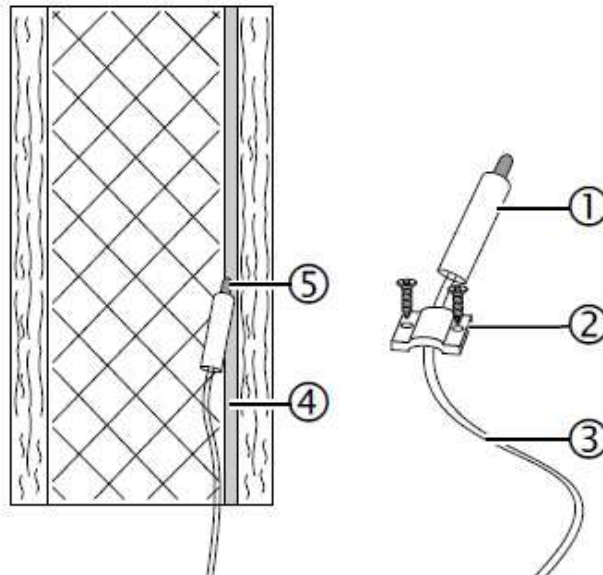

Fig. 5

**CAUTION - Incorrect measurements:** If the foil temperature sensor is not directly mounted to the foil, incorrect measurements can result. Mount the foil temperature sensor directly to the foil.

**NOTE:** The foil temperature sensor is only required for the infrared foil heating system.

1. Mount the sensor head 1 of the foil temperature sensor directly between the insulation and heating foil 4 .
2. Fix the foil temperature sensor with the strain relief 2 outside of the foil area.
3. Install 2-pin cable 3 in the cabin wall and fix in place with cable collars.

# WE DO IT FIRST.

## 1.6 Master/slave configuration

### 1.6.1 Master/Slave configuration of **two** wave.com4 Infra power units

**NOTE:** To increase the max. connection power (3 kW), there is an option of controlling two or more power units with an operating unit. For this, every additionally connected power unit must be configured as a slave.

In the delivered condition, the wave.com4 Infra infrared control is configured as a master. In order to use a power unit in slave mode, it must be reconfigured as follows:

Stick jumper JP1 in the box header "OPT3" as shown in Fig. 6 .

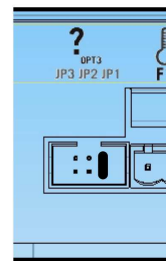

Fig. 6

WE DO IT FIRST.

### 1.6.2 Master/slave configuration of **three to five** wave.com4 Infra power units

If more than two power units are connected to each other, each slave power unit must be assigned its own slave address.

1. Loosen the four Phillips-head screws according to Fig. 7 and remove the housing cover of the wave.com4 Infra.
2. Address the slave power units according to the table in Fig. 7.
3. Put the housing cover on and refasten with the Phillips-head screws.

Jumper gesteckt = Jumper plugged in  
Abb 7 = Fig. 7

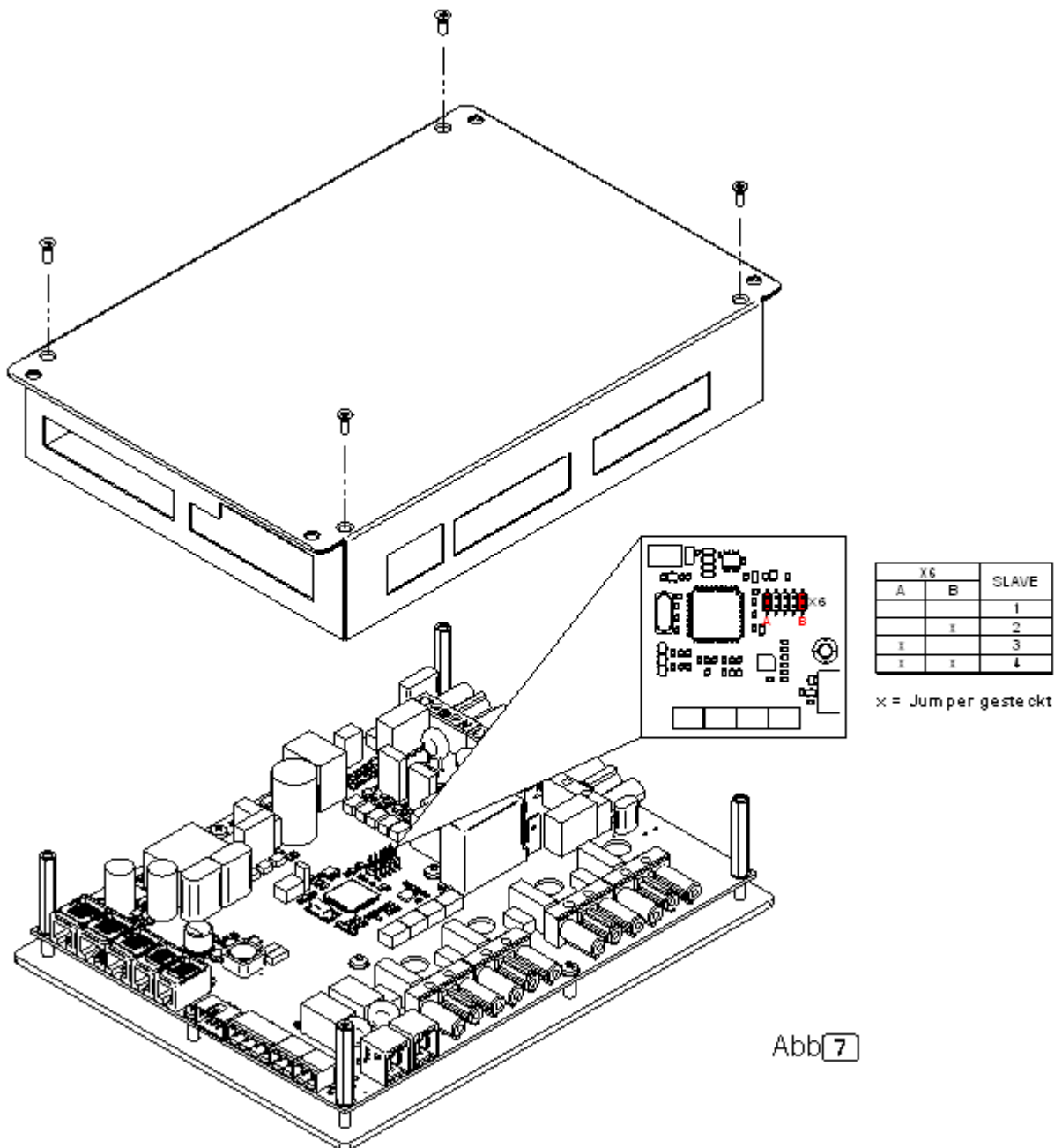

# WE DO IT FIRST.

## 1.7 Heating rod system configuration / foil system

**NOTE:** Among other things, the control is for regulating and controlling the interior temperature for

- infrared rod heating systems in the range of 30 - 70°C

**OR**

- infrared foil heating systems in the range of 30 - 50°C (max. permissible foil temperature measured via F2: 85°C)

**NOTE:** In the delivered condition, the wave.com4 Infra infrared control is configured for a heating rod system.

In order to use the device to operate infrared foils, the power unit must be reconfigured:

Stick jumper JP2 in the box header "OPT3" as shown in Fig. [8](#) .

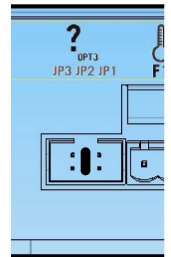

Fig. [8](#)

## 1.8 Activation of the opt. foil sensor for slave power units

If several power units are connected with one another, there is the option of evaluating other foil sensors.

For each connected power unit, an additional sensor can be connected.

Precondition is the operation in the foil system (see 1.7).

If the jumper JP2 is plugged into the SLAVE power unit (see Fig. [9](#)), the foil sensor is activated on this power unit.

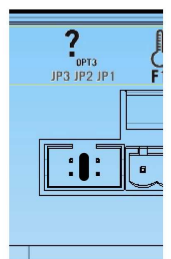

Fig. [9](#)

WE DO IT FIRST.

## 2. INSTRUCTIONS FOR THE USER

**Dear User,**

- Please read these instructions carefully before using the infrared control. This way, you can utilize all the advantages the device has to offer and prevent damage.
- When special problems occur which are not treated in detail in these instructions, contact your supplier for your own safety.
- Children should be supervised to make sure that they do not play with the device.
- This device is not meant to be used by persons (including children) with limited physical, sensory or mental capabilities or who lack experience and/or knowledge, unless they are supervised by a person responsible for their safety or have received instruction on how the device is to be used.
- Unauthorized changes or conversions to the infrared control are not allowed for safety reasons.
- Keep these instructions near the infrared control, in order to be able to look up safety information and important information for operation at any time.
- Subject to technical changes.

**WE DO IT FIRST.**

## General safety information

**WARNING - Fire hazard:** Before switching on the infrared control, make sure that no flammable objects are placed on or in front of the IR radiant heaters.

### Intended use:

- Among other things, the infrared control is for controlling and regulating the interior temperature
  - for infrared foil heating systems in the range from 30 - 50°C,
  - for infrared rod heating systems in the range 30 - 70°C.
- The infrared control may only be used for controlling and regulating 2 heating circuits with a maximum of 1.5 kW of heating power per heating circuit.
- The power unit may only be mounted and operated in connection with the operating unit included in the scope of delivery.

## 2.1 Operating modes

### 2.1.1 What operating modes are there?

- Dual heating circuit intensity control for infrared rod heating systems
- Room temperature regulation for infrared rod heating system
- Room temperature regulation for infrared foil heating system
- Program mode

### 2.1.2 What can I set?

- Power of the infrared heating rods in 8 stages (e.g. vitae) → 2 separate heating circuits
- Interior temperature in degrees Celsius
- Program number
- Heating time in minutes
- Light intensity in %
- Fan power in %

WE DO IT FIRST.

### 2.1.3 What setting ranges do I have?

- In the intensity mode in the following power stages:

Setting on the operating unit	Power of the radiators in %
0	0%
1	20%
2	33%
3	40%
4	50%
5	60%
6	66%
7	80%
8	100%

- The interior temperature can be set on the
  - infrared foil heating system, from 30 - 50°C,
  - infrared rod heating system, from 30 - 70°C.
- In program mode, five different programs can be set.
- The heating time can be set from 0-60 minutes.
- The light intensity can be set from 0-100% in steps of 10%.
- The fan power can be set from 0-100% in steps of 10%.

## 2.2 Cleaning

**CAUTION - Damage to device:** The operating unit of the infrared control must not have water poured over it or be cleaned with a lot of moisture. For cleaning, use a slightly moistened cleaning cloth which has some mild soap suds (dishwashing liquid) on it.

WE DO IT FIRST.



## 2.3 Error messages

The control is equipped with sophisticated diagnostic software. When switched on, a self-test is called up, and during operation, various states are checked. As soon as an error is detected, the control switches off, all operating symbols flash and an error number appears on the display. The following table provides information about the cause.

It is important to tell your service personnel this error number when making a complaint, since this makes successful repair on site possible or accelerates it. Restarting is only possible by completely switching off from the mains.

<b>Error number</b>	<b>Description</b>	<b>Remedy / cause</b>
E01	Thermal fuse defective.	Defective oven sensor, poor contact or thermal fuse not connected. Inform Service!
E02	Cabin temperature sensor F1 broken or short circuit	Defective temperature sensor or poor contact or short circuit
E03	Foil temperature sensor broken or short circuit.	Defective temperature sensor or poor contact or short circuit
E04	Communication error between the operating unit and power unit	Poor contact or defective connection cable, inform Service!

**WE DO IT FIRST.**

## 2.4 Operation

### 2.4.1 Display elements

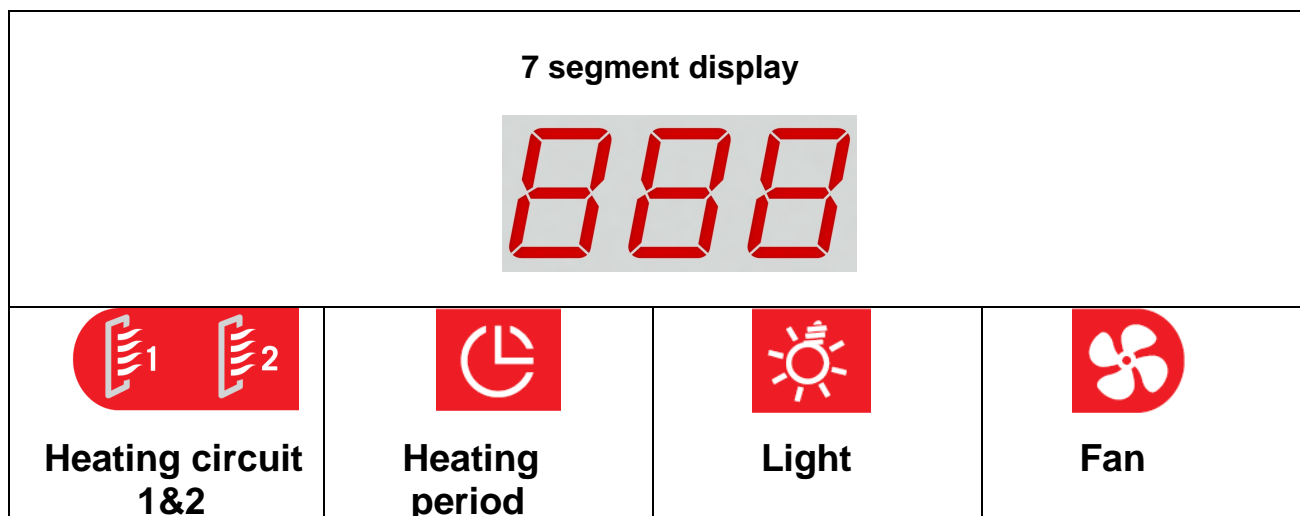

### 2.4.2 Operating elements

Mode key



+/- key



On/Off



WE DO IT FIRST.

## 2.5 Operating modes

### 2.5.1 Changing the operating mode

After switching on the control with the  key, the desired operating mode must be selected:





.....Intensity control



.....Room temperature control









.....Program mode

Set the desired mode by pressing the  or the  key.

To confirm the selection, please press the  key.

## 2.5.2. Intensity control mode





## Intensity control for infrared rod heating systems

Mode key		<b>Switch</b> among the <b>menu</b> items with MODE: Heating circuits 1&2, heating circuit 1, heating circuit 2, heating period, light and fan
Heating circuits 1&2:		set the desired <b>heating power</b> for both circuits with the +/- keys
Heating circuit 1:		Set the desired <b>heating power for heating circuit 1</b> with the +/- keys.
Heating circuit 2:		Set the desired <b>heating power for heating circuit 2</b> with the +/- keys.
Heating period:		Set the desired <b>heating period</b> with the +/- keys (5-minute steps from 5 to 60 minutes). The timer is started by pressing the On/Off key, an A appears on the display, the time runs backwards. By pressing the On/Off key again in the heating period menu, the timer is stopped. The control runs until it is switched off (max. 6 hours)
Light:		<b>Dim the lighting</b> with the +/- keys.
Fan:		Set the <b>fan power</b> with the +/- keys. By pressing the On/Off key, the fan is started. By pressing the On/Off key again in the fan menu, the fan is stopped.

WE DO IT FIRST.

2.5.3 Room temperature control mode:

Room temperature control for infrared rod/foil heating systems

<p>Mode key </p>	<p><b>Switch</b> among the <b>menu</b> items with MODE: Heater, heating period, light and fan</p>
<p>Temperature: </p>	<p>Set the desired <b>cabin temperature</b> with the +/- keys.</p>
<p>Heating period: </p>	<p>Set the desired <b>heating period</b> with the +/- keys (5-minute steps from 5 to 60 minutes). The timer is started by pressing the On/Off key, an A appears on the display, the time runs backwards. By pressing the On/Off key again in the heating period menu, the timer is stopped. The control runs until it is switched off (max. 6 hours)</p>
<p>Light: </p>	<p><b>Dim</b> the <b>lighting</b> with the +/- keys.</p>
<p>Fan: </p>	<p>Set the <b>fan power</b> with the +/- keys. By pressing the On/Off key, the fan is started. By pressing the On/Off key again in the fan menu, the fan is stopped.</p>

**NOTE:**

Among other things, the control is for regulating and controlling the interior temperature for:





- infrared rod heating systems in the range of 30 - 70°C

**OR**

- infrared foil heating systems in the range of 30 - 50°C  
(max. permissible foil temperature measured via F2: 85°C)

## 2.5.4 Program mode:

## Program mode for infrared rod heating systems

<b>Mode key</b> 	<b>Switch</b> among the <b>menu</b> items with MODE: Heater, heating period, light and fan
<b>Temperature:</b> 	Set the desired <b>program number</b> with the +/- keys.
<b>Heating period:</b> 	Set the desired <b>heating period</b> with the +/- keys (5-minute steps from 5 to 60 minutes). The timer is started by pressing the On/Off key, an A appears on the display, the time runs backwards. By pressing the On/Off key again in the heating period menu, the timer is stopped. The control runs until it is switched off (max. 6 hours)
<b>Light:</b> 	<b>Dim the lighting</b> with the +/- keys.
<b>Fan:</b> 	Set the <b>fan power</b> with the +/- keys. By pressing the On/Off key, the fan is started. By pressing the On/Off key again in the fan menu, the fan is stopped.

# WE DO IT FIRST.

**Program description:**

Program number:	Description	Intensity	Program duration
Pr 1	Relaxation	Low	40 min
Pr 2	Warm-up	Medium	25 min
Pr 3	Endurance (short)	Medium	30 min
Pr 4	Endurance (long)	High	35 min

Program 1 is for relaxation and is characterized by a continuous heat curve. Programs 2, 3 and 4 have been developed for exercise activities. Here, program 2 is for the warm-up phase before exercise. Programs 3 and 4 are designed for the relaxation phase after exercising.

**Applications for the individual programs:**

Program 1: Relaxation and to relieve tension

Program 2: Warming up muscles before exercise

Program 3: After exercise activities over a short period of time (e.g. 1/2 h of jogging)

Program 4: After exercise activities over a longer period of time (e.g. 2 h of tennis)



# WE DO IT FIRST.

## 2.6 Extended functions and setting options

### 2.6.1 Remote start

**NOTE:** In the delivered condition, the remote start function is deactivated.

To activate the remote start function, proceed as follows:



In the heating menu, keep the  key pressed for 2 seconds. This way, you first reach the operating mode menu. By pressing the  key, you reach the remote start menu.

**F50**

.....Remote start deactivated

**F51**

.....Remote start activated

Set the desired mode with the  or  key

Confirm the selection by pressing the  key.







### 2.6.2 Resetting the max. heating period

**NOTE:** In the delivered condition, the max. heating time is set to 6 hours.

To change the setting for the max. heating time in the heating period menu, keep the



	..... max. runtime 6 hours
	..... max. runtime 12 hours
	..... max. runtime 24 hours



Set the desired max. heating period with the  or  key.

Confirm the entry by pressing the  key.

### 2.6.3 Controlling the potential-free switching outputs

**NOTE:** The control has two potential-free switching outputs, which are available for various applications (e.g. opening and closing a motorized venting flap)

To switch both potential-free switching outputs Opt1 and Opt2 on/off, the

 or  key must be kept pressed for 2 seconds.

On the display, the status of relay1 or relay2 is then displayed:

 .....Relay closed

 .....Relay open

### 3 TECHNICAL DATA

#### 3.1 OPERATING UNIT

Connection	4-pin with supply and communication lines
Current consumption	5 V= / < 100 mA normal operation (< 0.5 W)
Time interval/el. hour glass	0 to 60 minutes
Ambient conditions	0 °C – 110°C, max. 99 % rel. humidity, non-condensing!
Housing	Flush-mounted box; board; wooden front with temperature-resistant foil
Fastening	Board via M2, 5 bolts on wooden front; rear side with flush-mounted box
Dimensions: L x W x D	120 x 92 x 44,5 mm
Weight	~ 212 g without cable and unpackaged

#### 3.2 POWER UNIT

Nominal voltage	230 V AC; 50/60 Hz
Operating unit connection	4-pin with 5 V= supply and communication; Length: 10 m
Control voltage	Low voltage 5 V=
Power cable	3 x 1.5 mm <sup>2</sup> for light, electronics and heating elements
Light connection	with built-in <b>reverse</b> phase control dimmer, for 2 (3)-pin connection for 230 V light bulb(s); <b>max. 60 W</b>
Fan connection	with built-in phase control dimmer, for 2 (3)-pin connection of the 230 V fan; <b>max. 50 W</b>
Temperature sensor	2-pin; Semiconductor sensor -9°C to 140°C
Setting precision	+/- 2°C; +/- 1 min.
Power consumption	max. 5 W in standby mode
Ambient conditions	0°C to max. 4°C, max. 95% rel. humidity, non-condensing!
Housing	IP20
Fastening	Screw on via 4 fastening bores for M4x16
Dimensions: L x W x H	230 x 170 x 46.6 mm
Weight	~1114 g unpackaged

WE DO IT FIRST.